

OPPHENGSSYSTEM FOR SKILT

OPPHENGSSYSTEM FOR SKILT

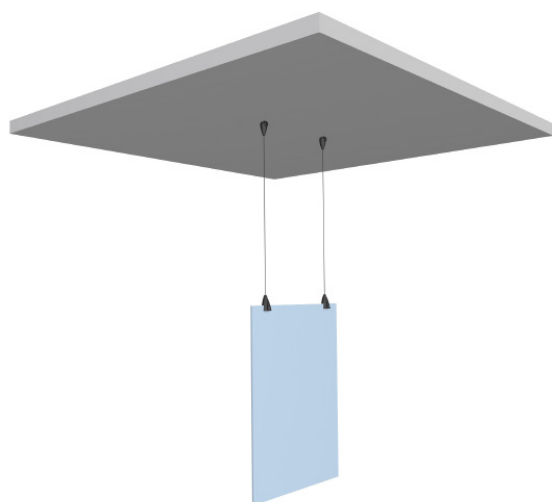
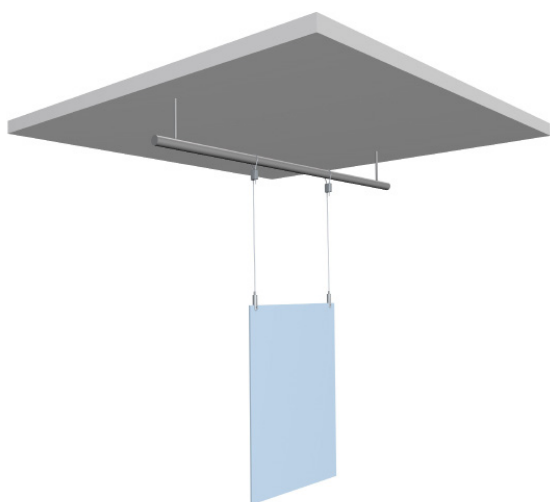
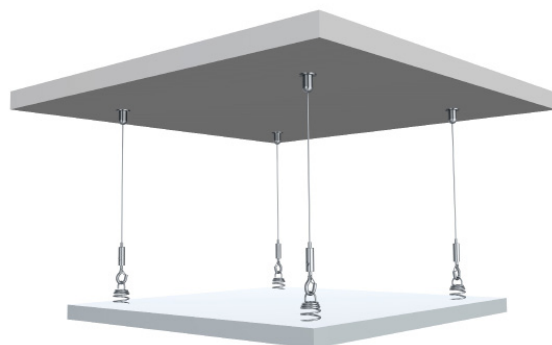
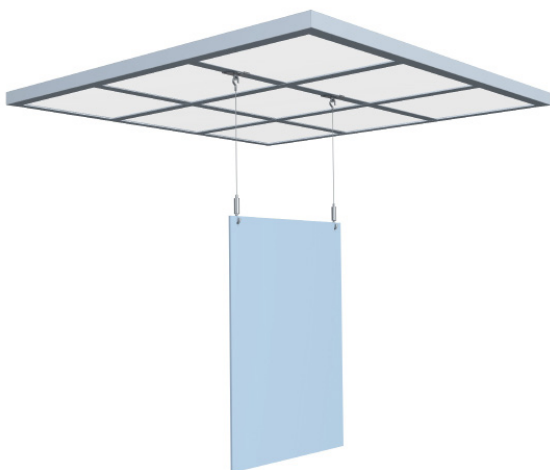
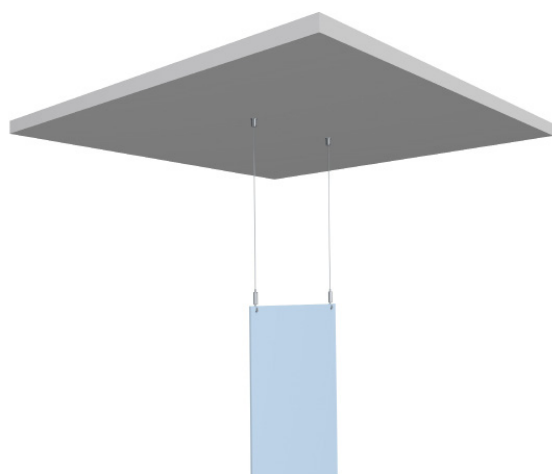
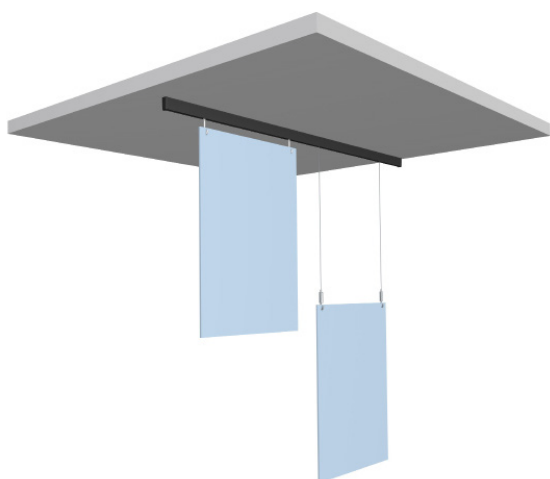
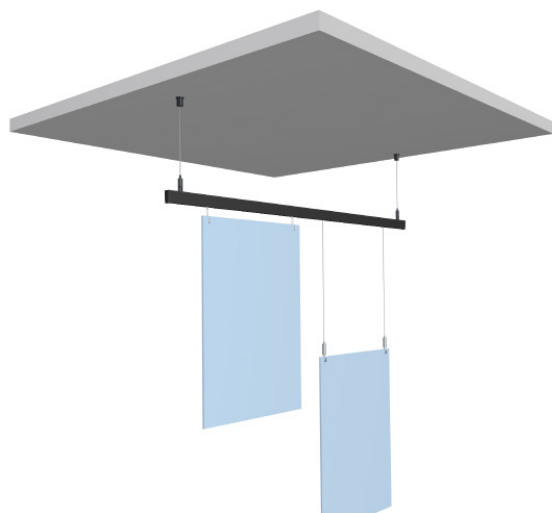

OPPHENGSSYSTEM FOR SKILT

XPO RAIL

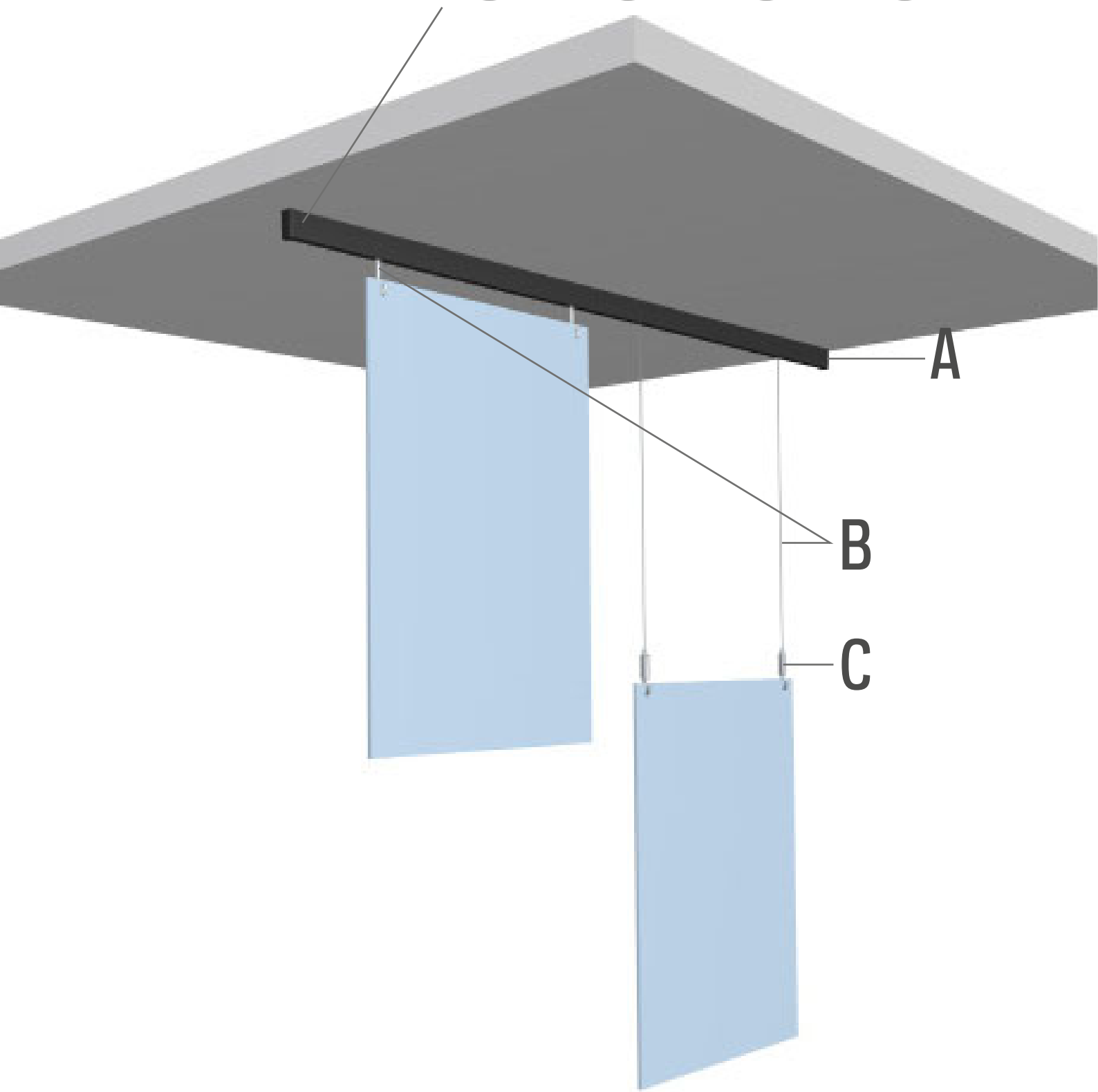
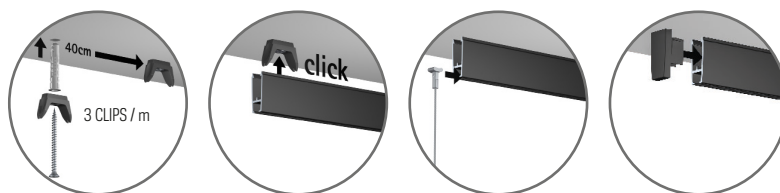

KOMBINASJON VIST:



- A + B3
- A + B1 + C3

MULIGE KOMBINASJONER:





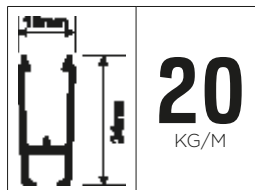

- A + B1/B2 + C1/C2/C3/C4/C5
- A + B3

XPO RAIL



A

| A | | |
|---|---|---|
|  |  |  |
| XPO RAIL 200 cm SORT | XPO RAIL 200 cm HVIT PRIMER | XPO RAIL 200 cm ALU BØRSTET |
| 05.15201 | 05.15200 | 05.15202 |







| A | | | | | | |
|---|---|---|---|---|---|---|
|  |  |  |  |  |  |  |
| ENDESTYKKE XPO RAIL SORT | ENDESTYKKE XPO RAIL HVIT | CLIP CLICK&CONNECT XPO RAIL | PLUGG (Ø 5 mm) | SKRUE | MONTERINGSETT XPO RAIL HVIT 200 CM | MONTERINGSETT XPO RAIL SORT/ALU 200 CM |
| 05.15030 | 05.15020 | 05.15010 | 9.4929 | 9.4931 | 5092 | 5093 |

B

| B1 | B2 | B3 |
|---|---|---|
|  |  |  |
| STÅLWIRE + SLIDER 1,2 mm 200 cm SORT | STÅLWIRE + SLIDER 1,2 mm 200 cm NICKEL | TWISTER HOOK |
| 7807.200 | 7807.210 | 9.4510 |

C

| C1 | C2 | C3 | C4 | C5 |
|---|---|---|---|---|
|  |  |  |  |  |
| STÅLWIRE HOOK AUTO GRIP 1,2 mm ST01BL | STÅLWIRE HOOK AUTO GRIP 1,2 mm ST01NI | STÅLWIRE HOOK AUTO GRIP 1,2 mm ST02NI | STÅLWIRE HOOK AUTO GRIP 1,2 mm ST03NI | STÅLWIRE CLAMPHOOK AUTO GRIP 1,2 mm STC01NI |
| 7807.010 | 7807.020 | 7807.030 | 7807.040 | 7807.050 |

* INNHOLD MONTERINGSETT

| | | | AANTAL 200 cm |
|---|---------------------|---------------------------------|---------------|
|  | 05.15010 | CLIP XPO RAIL | 6x |
| | 9.4931 | PLUGG FISCHER 5 mm | 6x |
| | 9.4929 | SKRUE FOR PLUGG FISCHER 5 mm | 6x |
| | 05.15020 / 05.15030 | ENDESTYKKE XPO RAIL HVIT / SORT | 2x |
| | 2639 | VEILEDNING | 1x |



Artiteq benytter seg av et Fischer UX 5x30 R-PLUGGger i kombinasjon med våre opphengssystemer. Fischer UX 5x30 R-PLUGGger kan brukes i mange forskjellige materialer, som betong, stein og gips. Avhenging av materialet, kan PLUGGgen bære maksimalt 30 kg. Boret som brukes med PLUGGgen må ha en diameter på 5 mm. PLUGGgen er 30 mm lang. Skruen som brukes til PLUGGgen er 38 mm lang og har en diameter på 3,5 mm (for bruk i kombinasjon med en PZ2-bit)

For å kunne avgjøre maksimal bæreevne for et opphengssystem for skilt, er det viktig å vite hva slags monteringsmateriell som brukes og hvilken flate det vil festes til. Komponentene til opphengssystemet for skilt har alle en maksimal bæreevne. Den angitte bæreevnen for komponenten gjelder den, og ikke den totale bæreevnen for opphengssystemet i sin helhet. For hele opphengssystemet, vil den anbefalte totale bæreevnen innebære monteringsmaterialene i kombinasjon med de respektive materialene, veie tyngst.

For hvert enkelt opphengssystem for skilt, må vekten du ønsker å henge opp være i balanse med den maksimale bæreevnen for monteringsmaterialet. Dersom opphengssystemet skal henges opp fra OGRE komponenter, som for eksempel nedfelte tak, må du vite den maksimale lasten for denne komponenten før våre opphengssystemer monteres. I tabellen nedenfor, er den maksimale bæreevnen for Fischers PLUGGger i kombinasjon med en rekke materialer.

| TYPE | | UX 5X 30 | |
|---|----------------------------|----------|------|
| RECOMMENDED LOADS IN THE RESPECTIVE BASE MATERIAL F_{REC}²⁾ | | | |
| Concrete | ≥ C20/25 | [kN] | 0,30 |
| Solid brick | ≥ Mz 12 | [kN] | 0,20 |
| Perforated sOG-lime brick | ≥ KSL 12 | [kN] | 0,30 |
| Vertically perforated brick | ≥ Hlz 12 | [kN] | 0,20 |
| Aerated concrete | ≥ AAC 4 | [kN] | 0,15 |
| Gypsum plasterboard | 12,5 mm | [kN] | 0,10 |
| Gypsum plasterboard | 25 mm | [kN] | 0,10 |
| Gypsum fibreboard | (Fermacell) | [kN] | 0,20 |
| Gypsum block | ρ ≥ 0,9 kg/dm ³ | [kN] | - |



- 1 Required safety factors are considered.
2 Valid for tensile load, shear load OG oblique load under any angle

| ART. NO. | BESKRIVELSE | MAKS. VEKT BELASTNING |
|----------|---|-----------------------|
| 7807.060 | Suspension bracket Xpo Rail 1,2 mm | 15 kg |
| 7807.200 | STÅLWIRE + slider 1,2 mm 200 cm SORT | 15 kg |
| 7807.210 | STÅLWIRE + slider 1,2 mm 200 cm nickel | 15 kg |
| 7807.100 | Ceiling Bracket SORT C01BL | 15 kg |
| 7807.110 | Ceiling Bracket nickel C01NI | 15 kg |
| 7807.140 | Ceiling Suspension auto grip 1,2 mm CS01NI | 15 kg |
| 7807.350 | STÅLWIRE 7x7 1,2 mm 10 m | 15 kg |
| 7805.052 | Loop Hanger 1,0 mm - 1,5mm | 10 kg |
| 7807.120 | Recessed Ceiling Clip 20 mm | 5 kg |
| 7807.130 | Recessed Ceiling Clip 20 mm + suspension auto grip 1,2 mm | 5 kg |
| 7807.310 | STÅLWIRE + hook 1,2 mm 300 cm | 15 kg |
| 7807.010 | STÅLWIRE Hook auto grip 1,2 mm ST01BL | 15 kg |
| 7807.020 | STÅLWIRE Hook auto grip 1,2 mm ST01NI | 15 kg |
| 7807.030 | STÅLWIRE Hook auto grip 1,2 mm ST02NI | 15 kg |
| 7807.040 | STÅLWIRE Hook auto grip 1,2 mm ST03NI | 15 kg |
| 7807.400 | Acoustic Spring 01-NI | 5 kg |
| 7807.050 | STÅLWIRE Clamphook auto grip 1,2 mm STC01NI | 15 kg |